

1

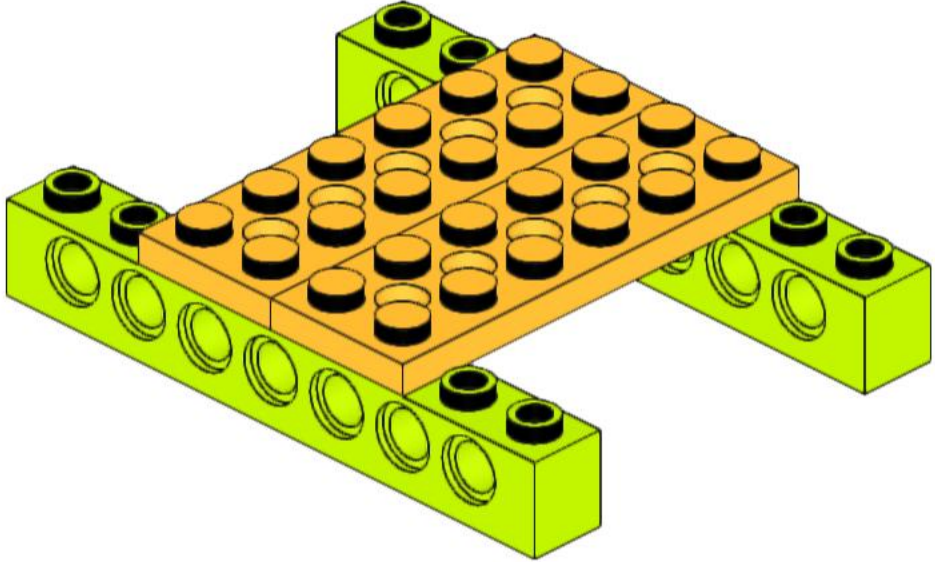

2

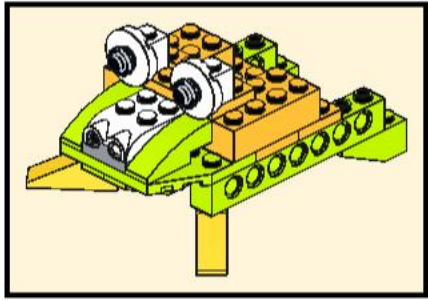
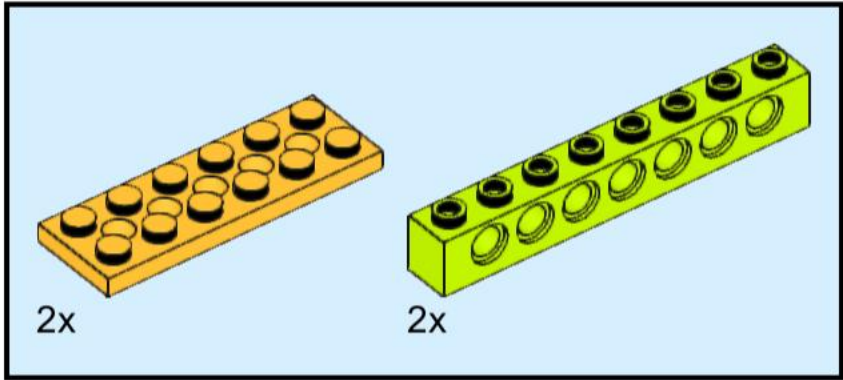
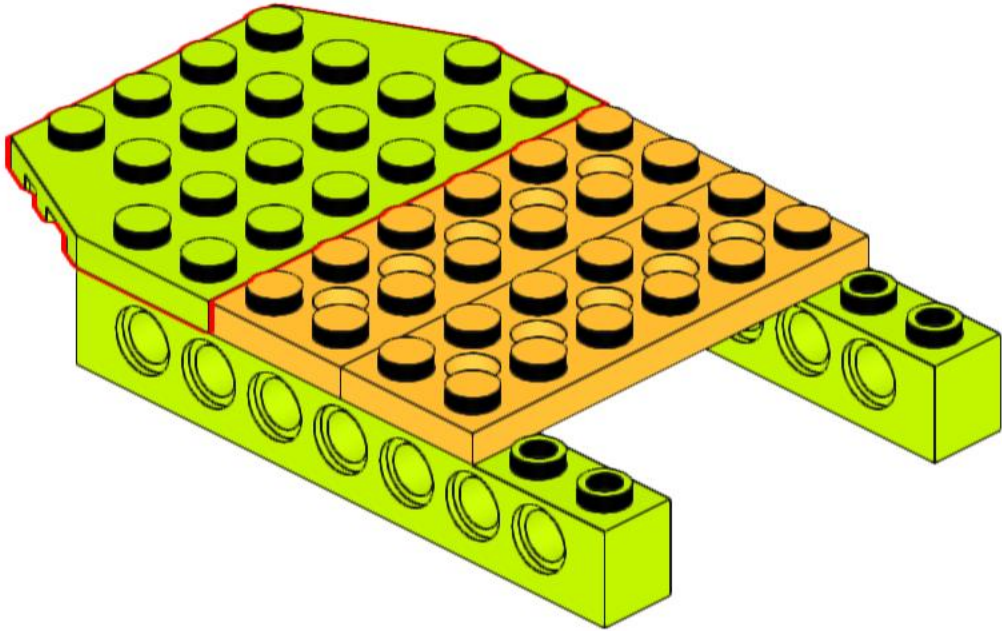
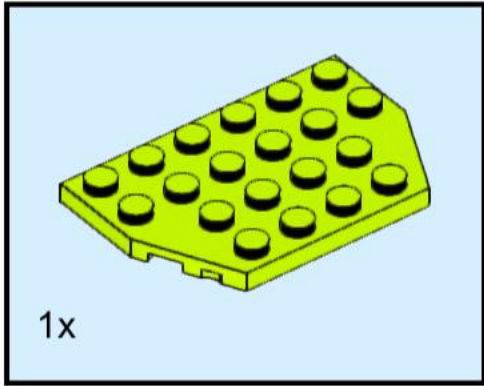

3

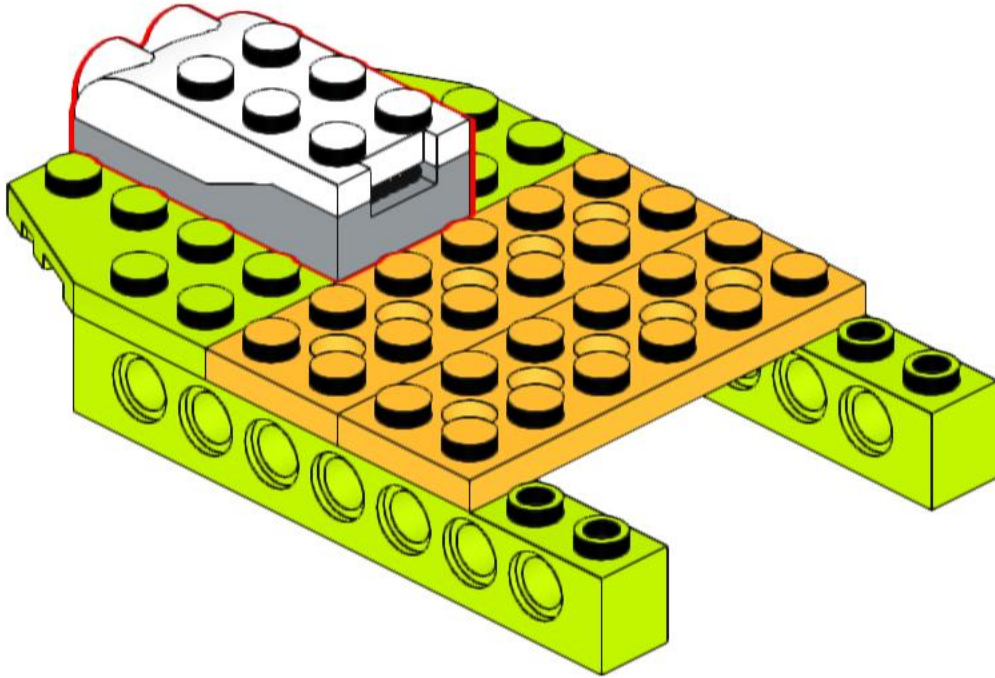
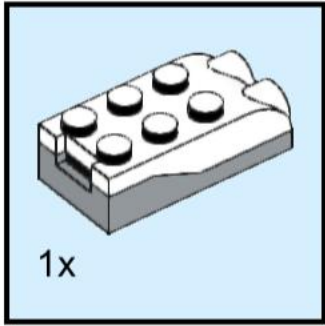

4

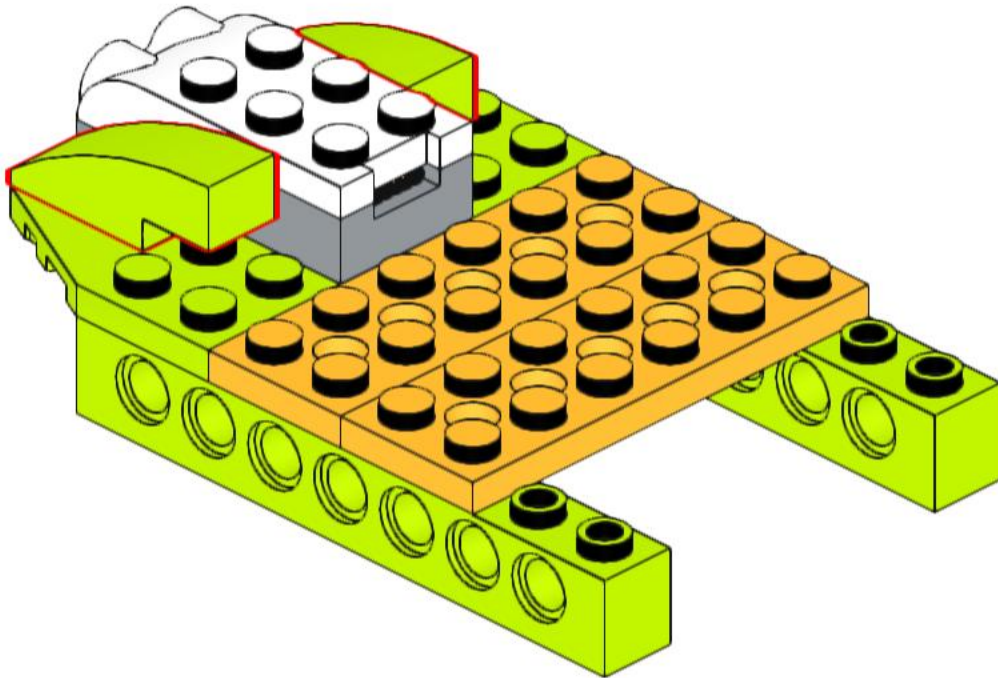
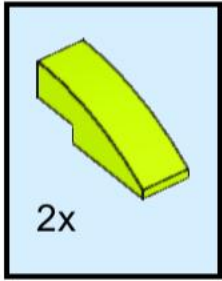

5

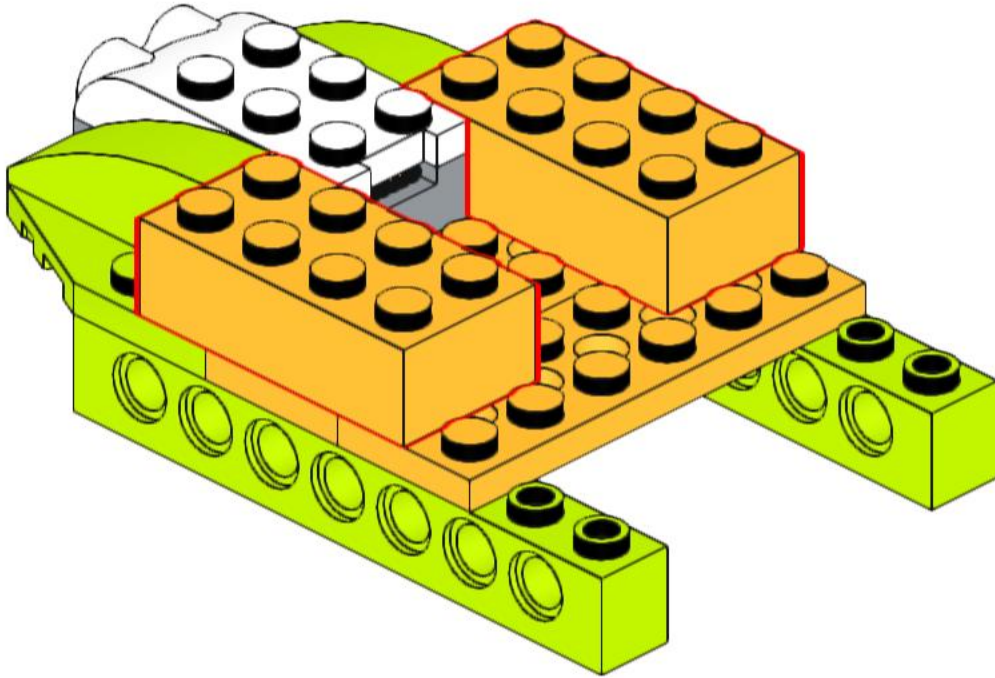
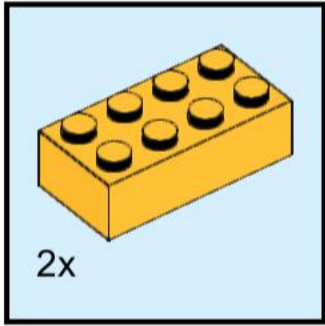

6

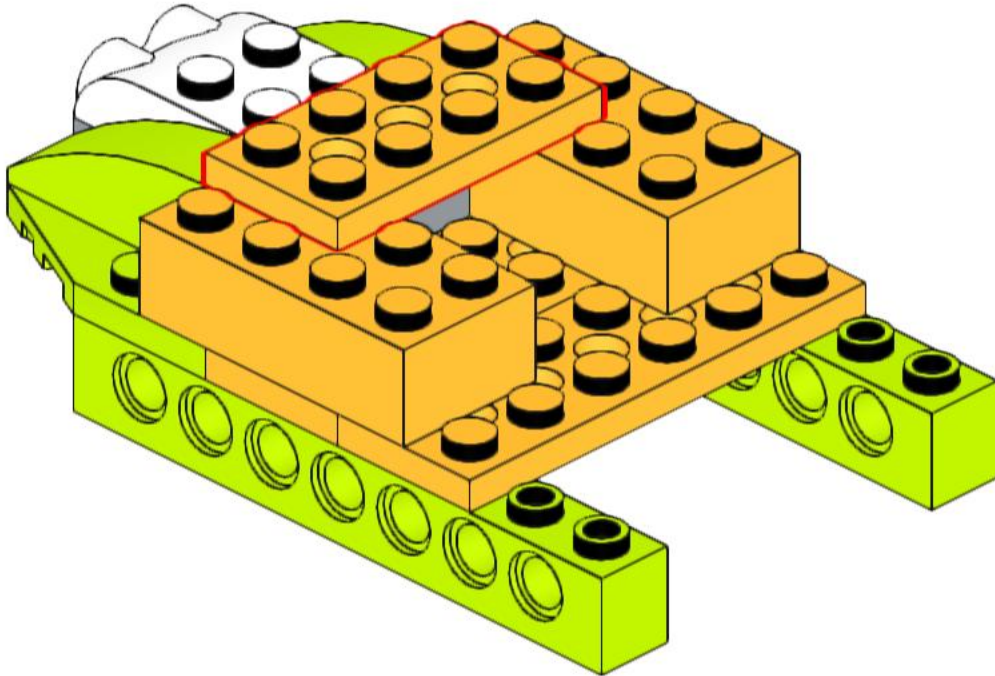
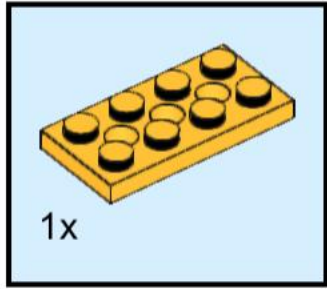

7

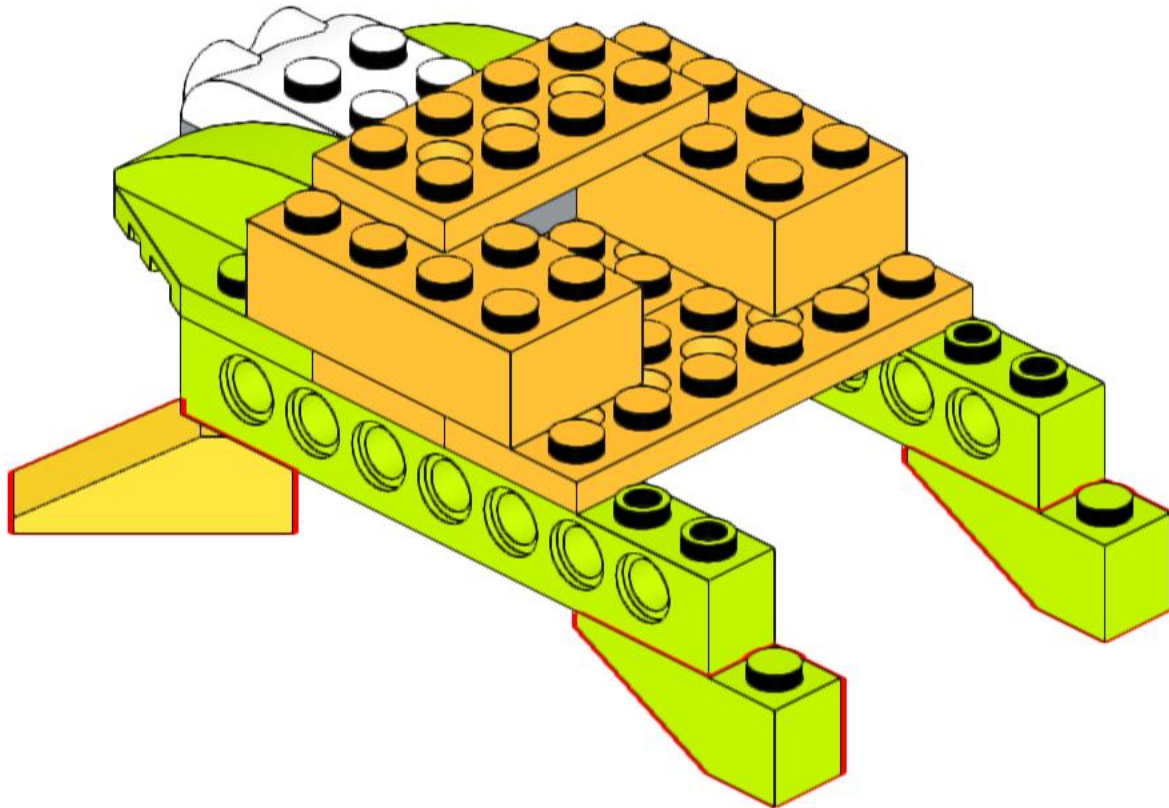
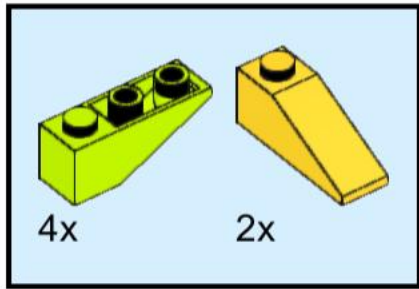

8

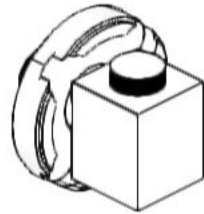
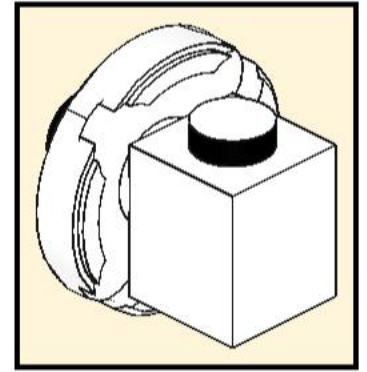
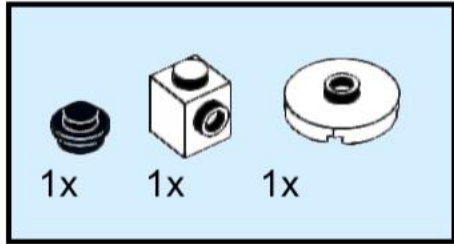



9

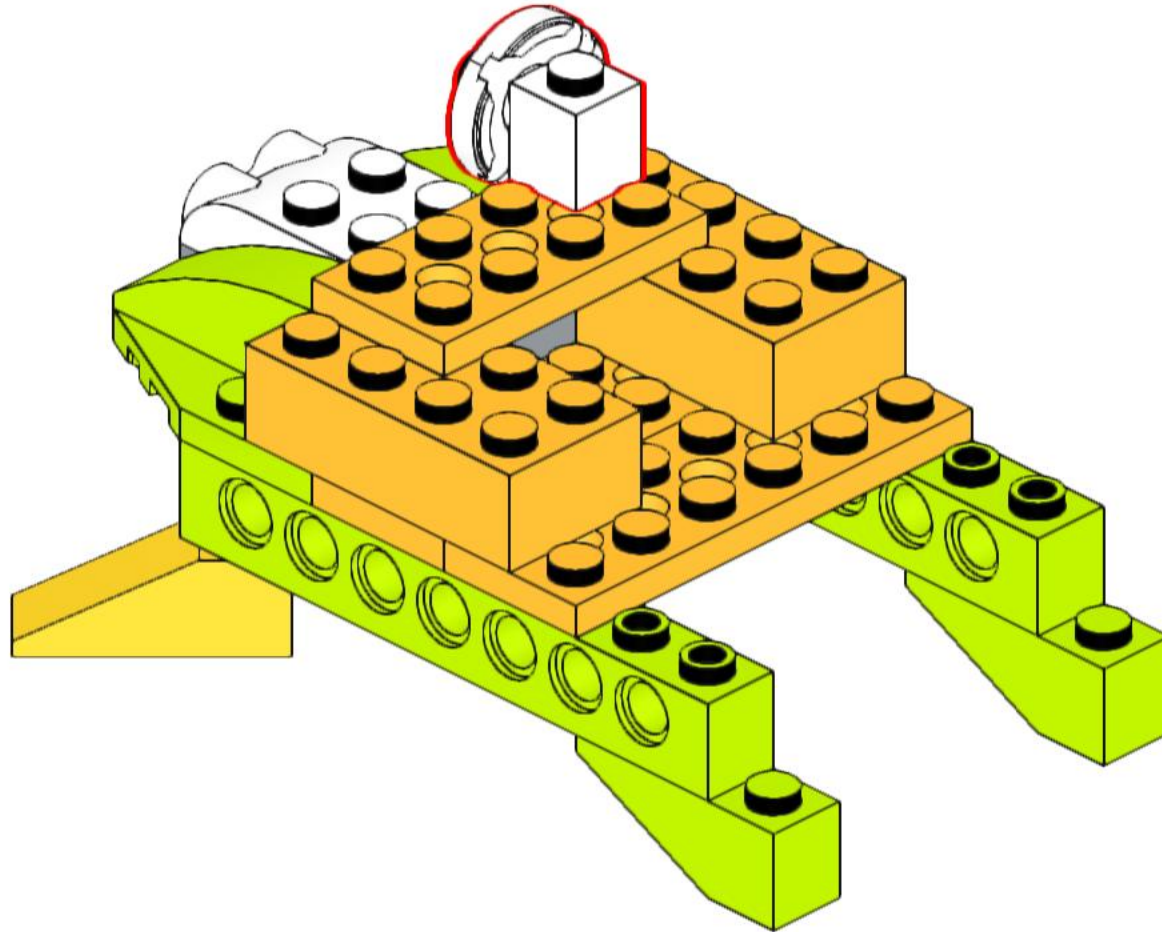

# 10

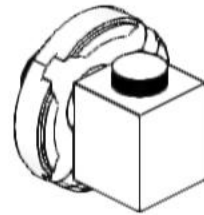
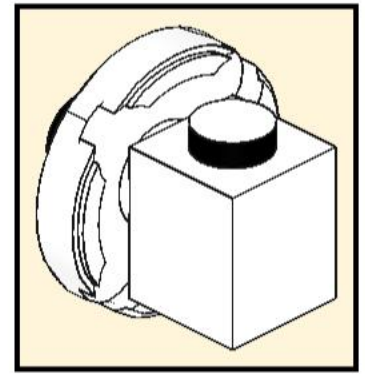
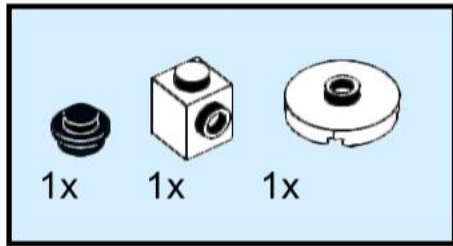

11

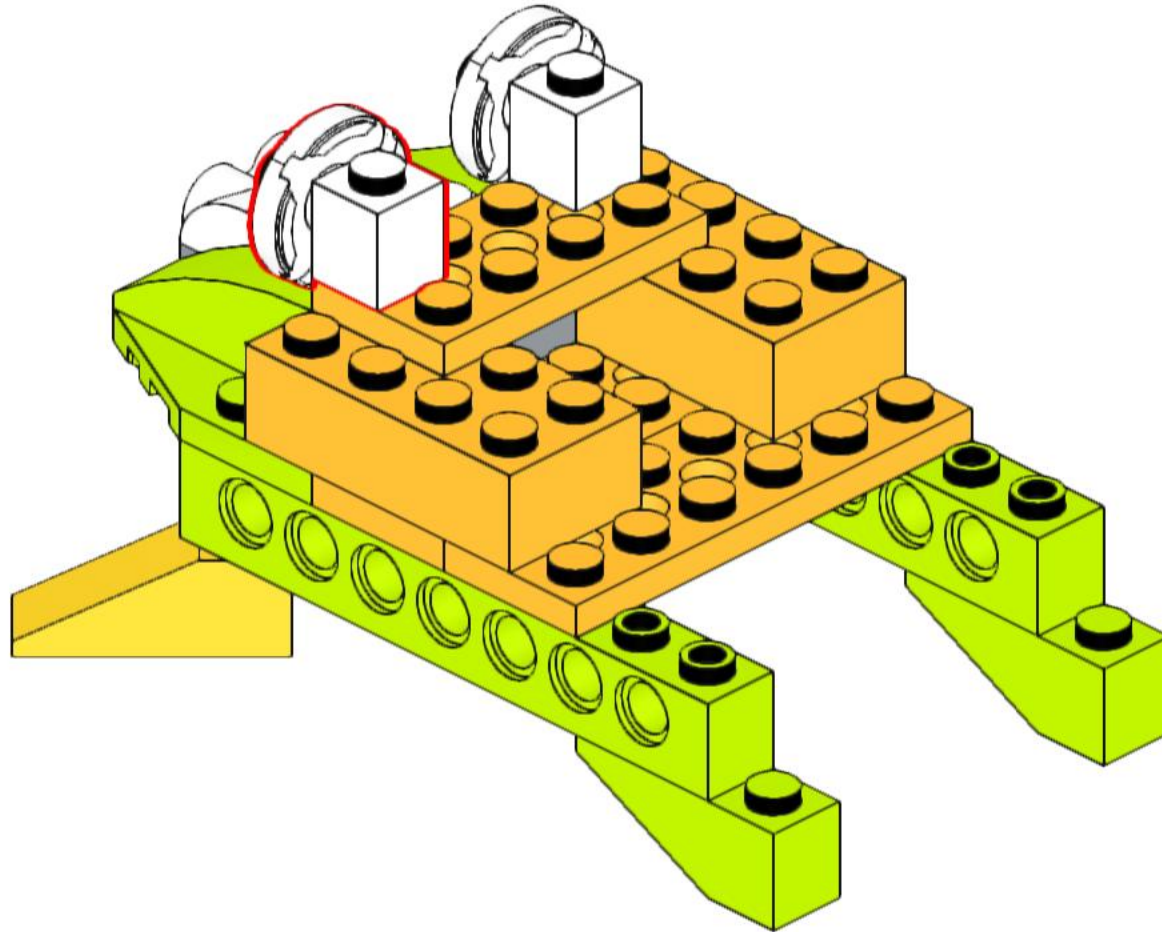

12

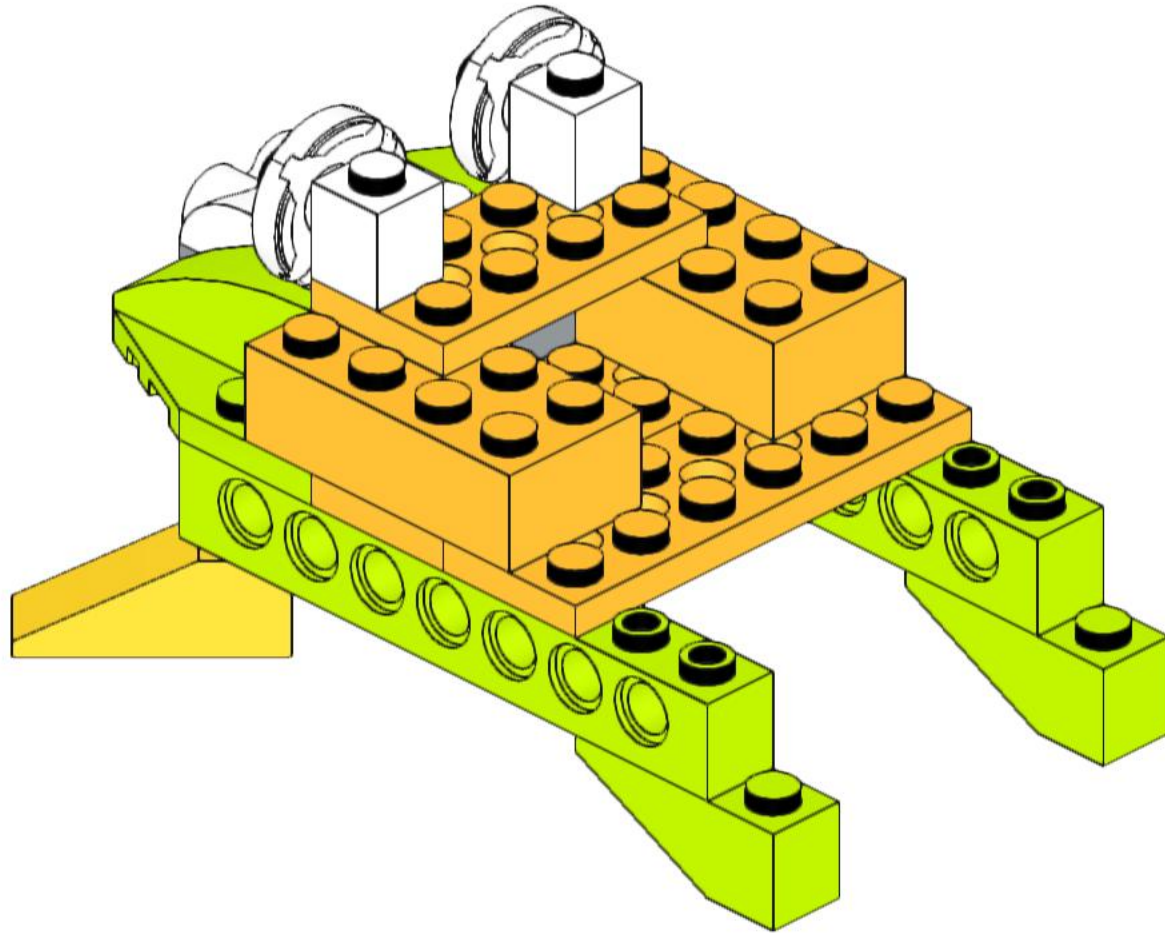

# 13

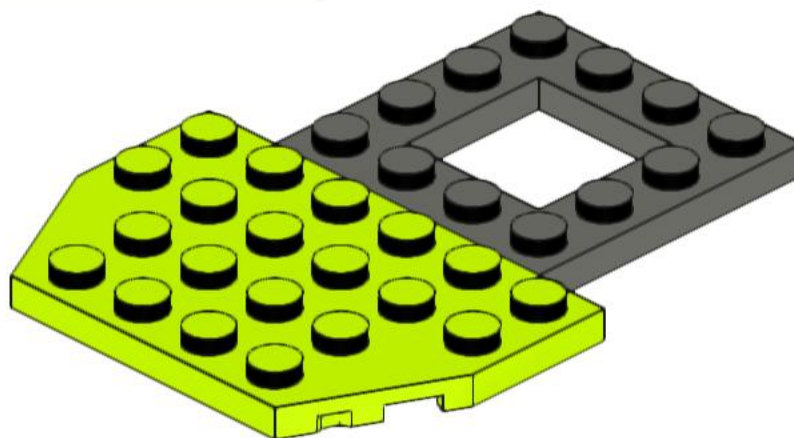
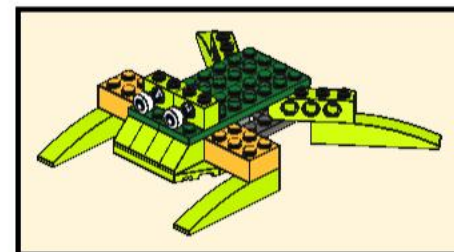
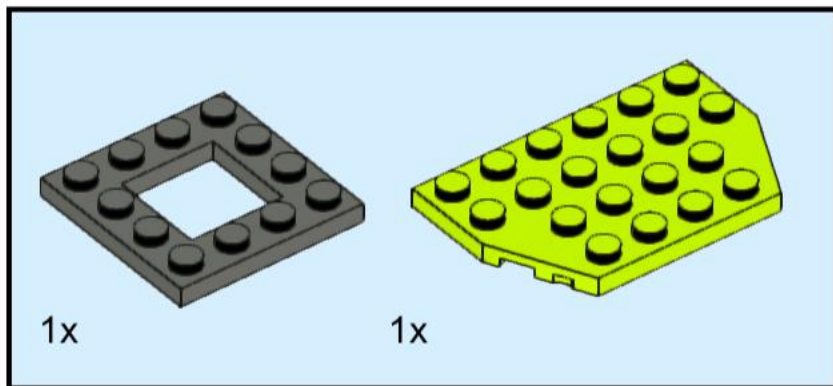

# 14

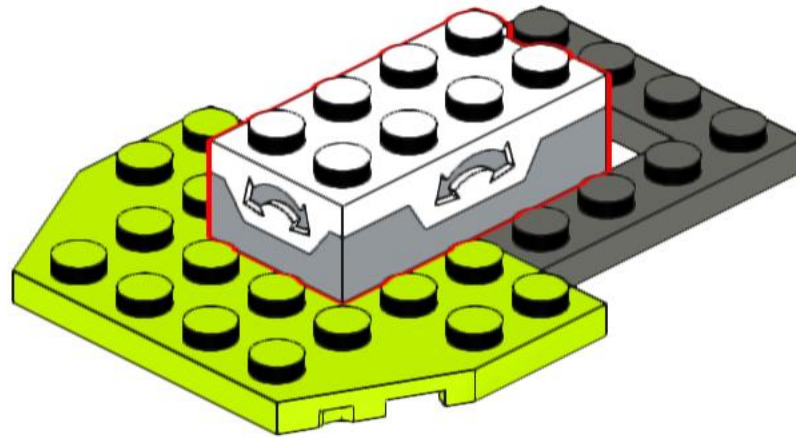
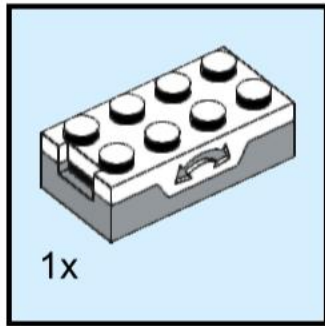

# 15

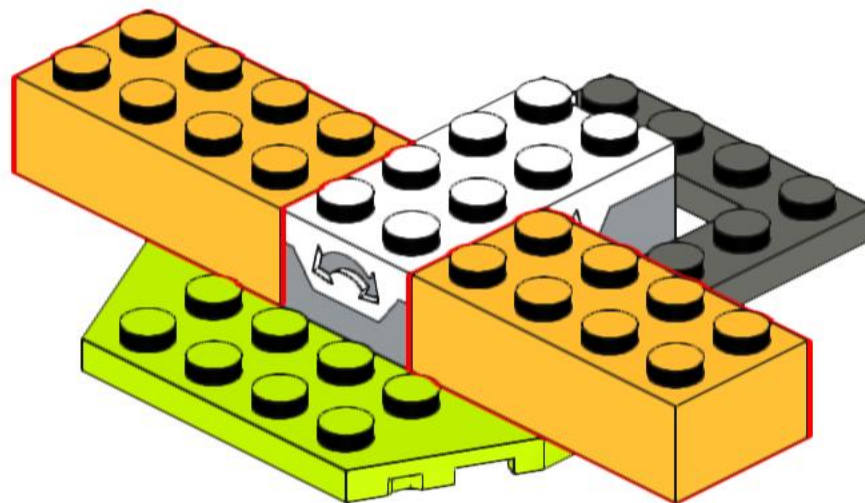
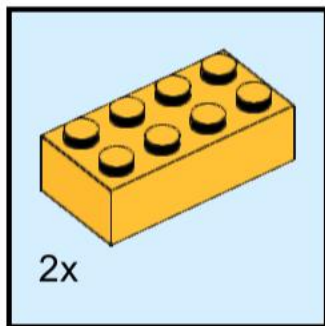

# 16

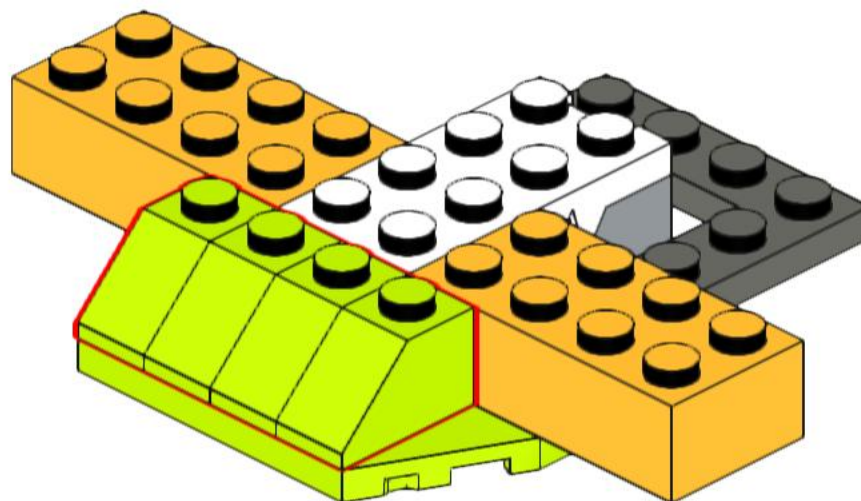
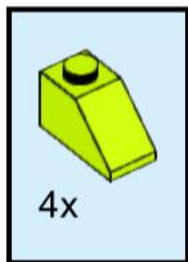



# 17

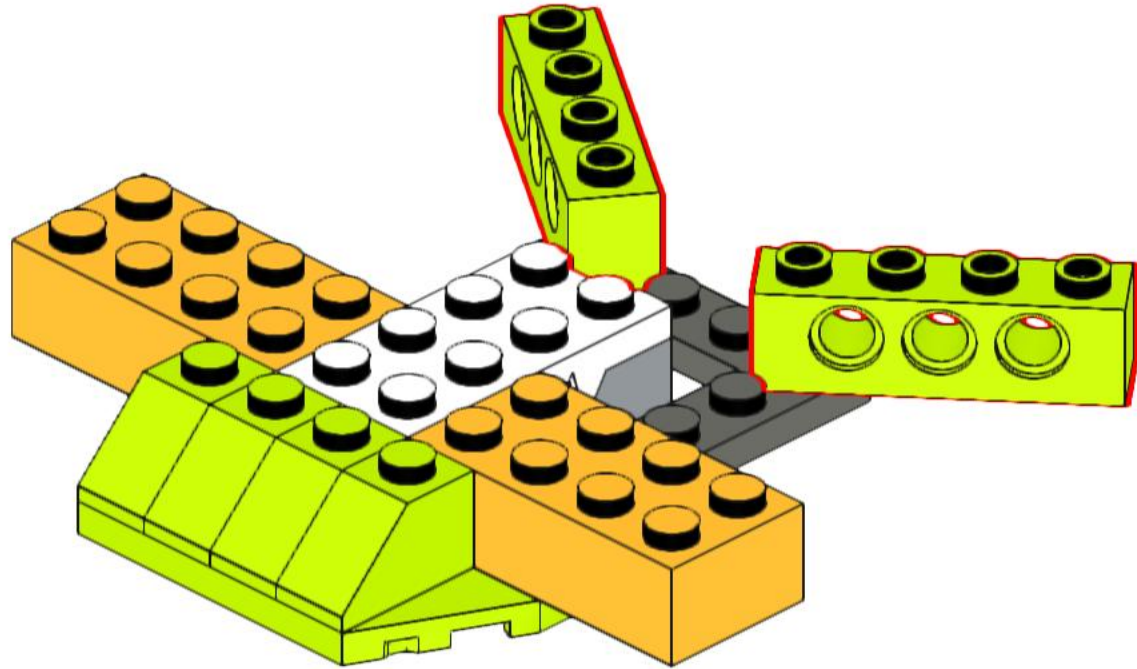
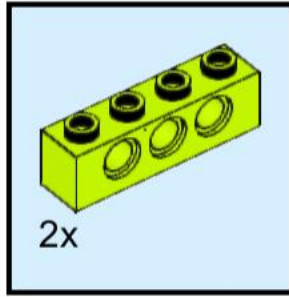

# 18

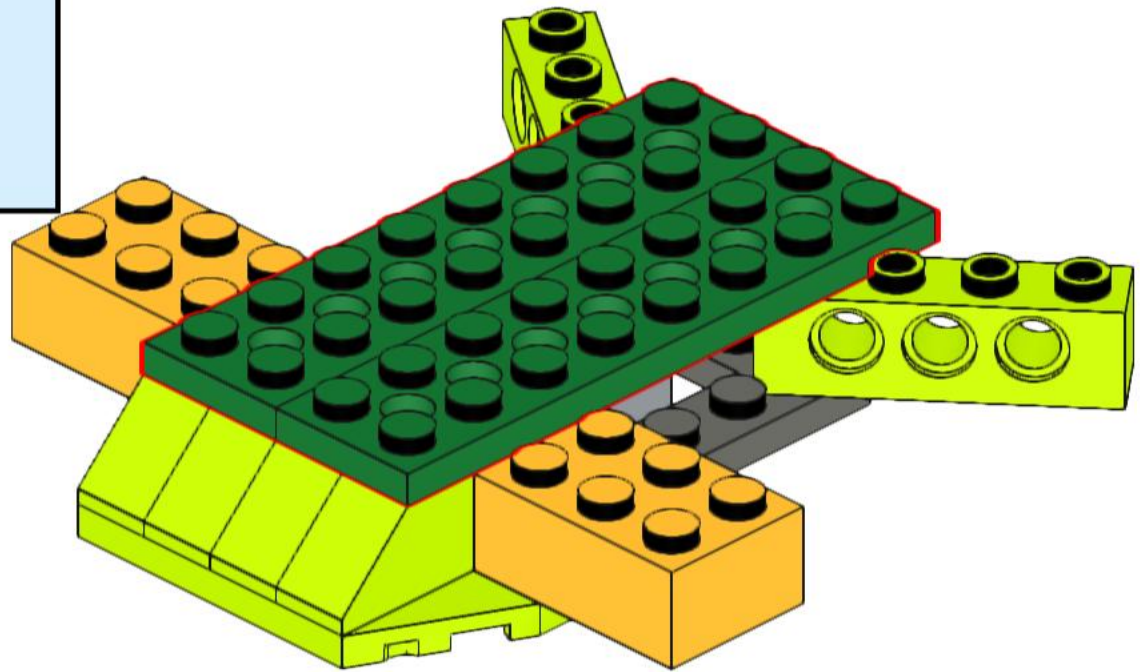
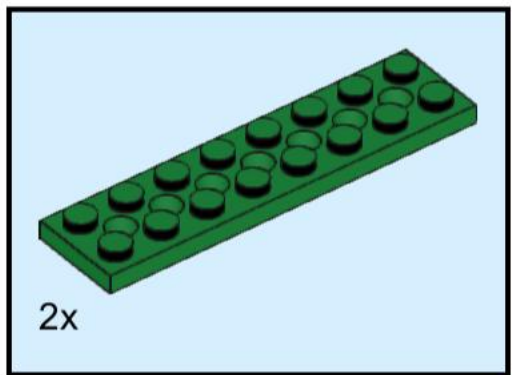

# 19

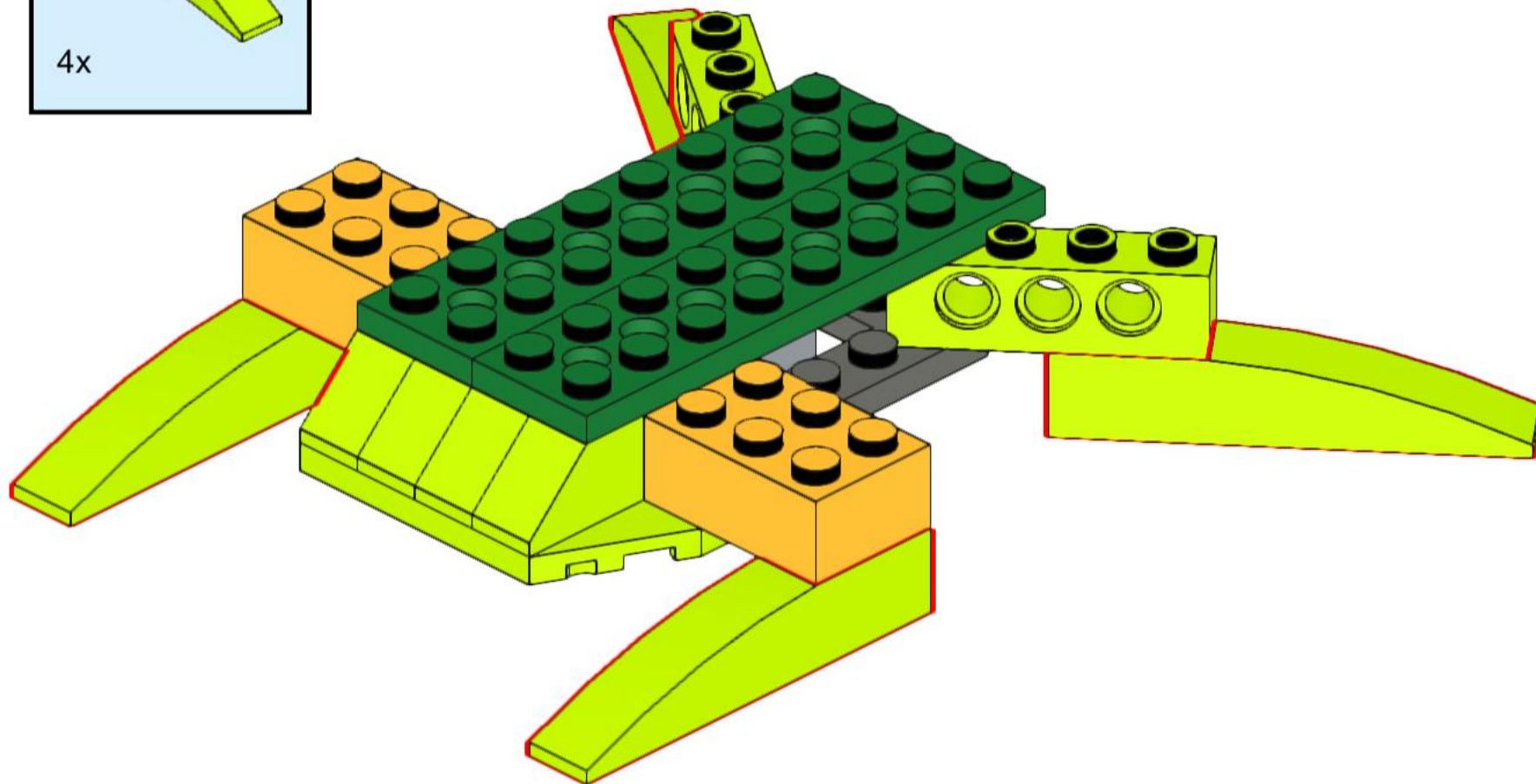
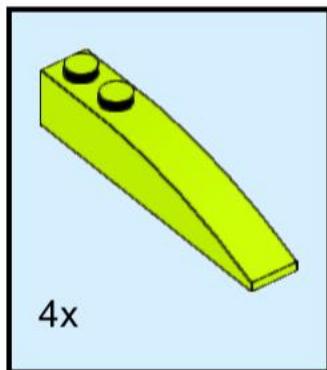

# 20

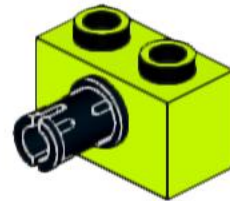
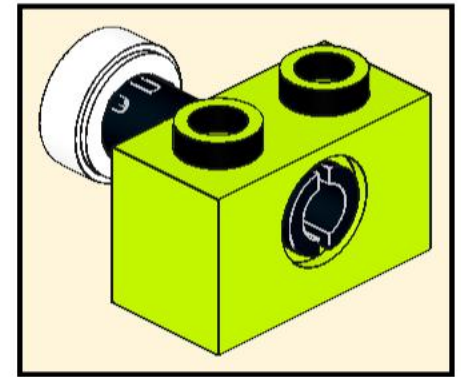
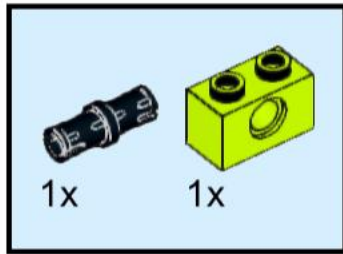

21

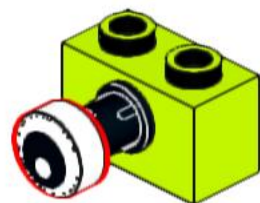
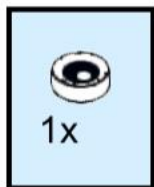

22

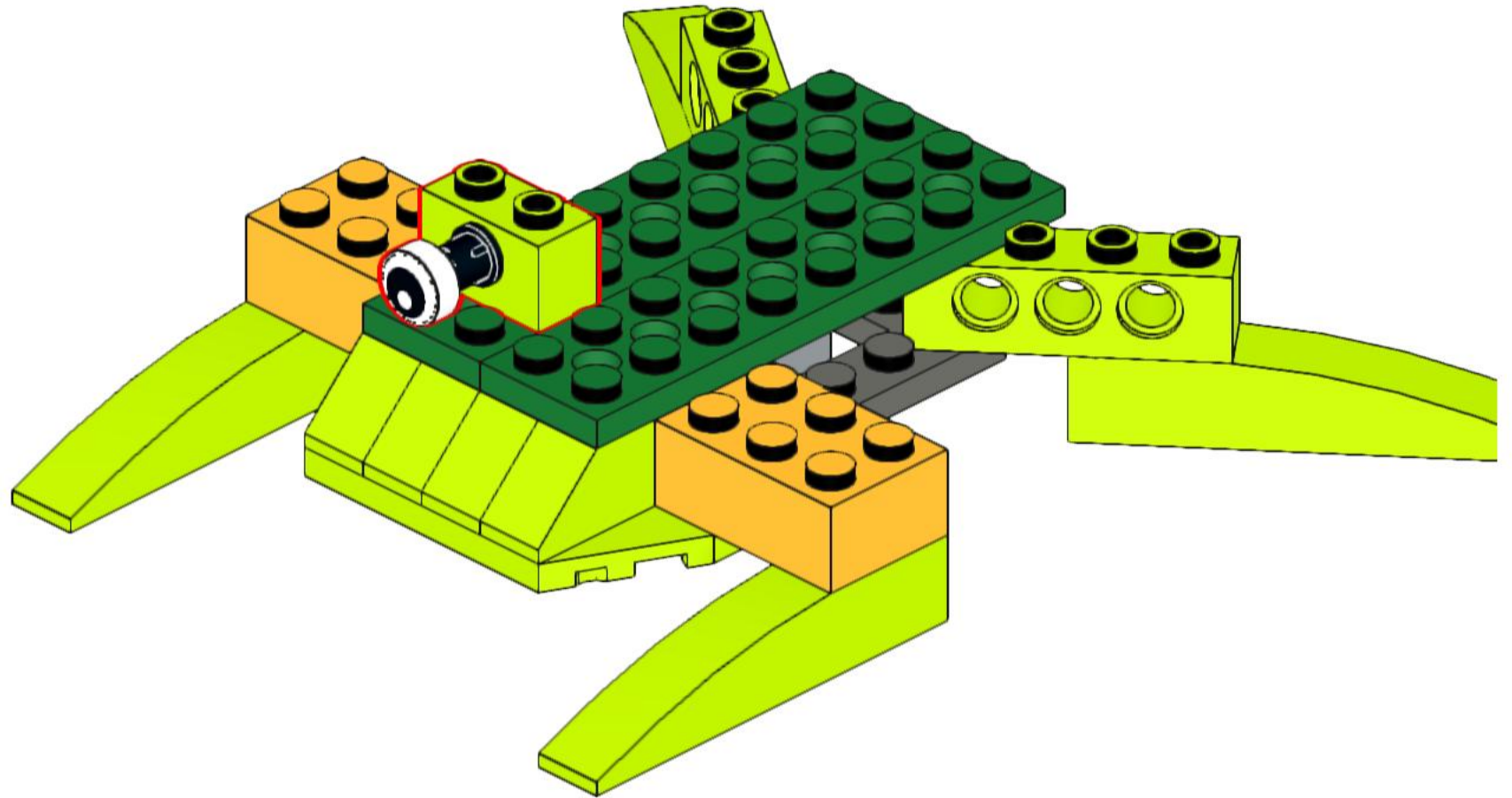

# 23

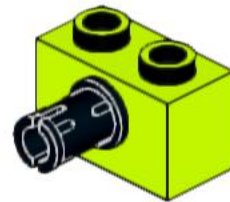
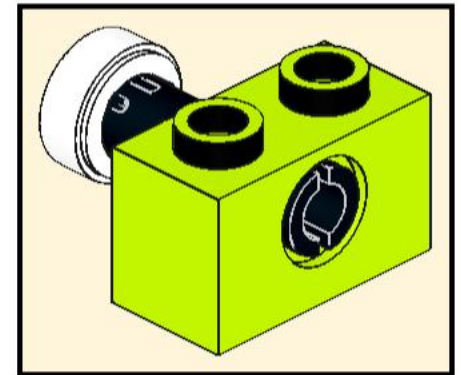
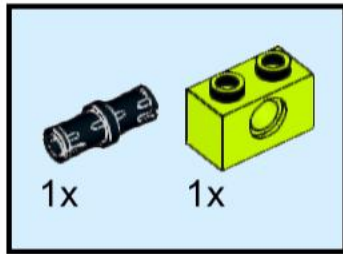

24

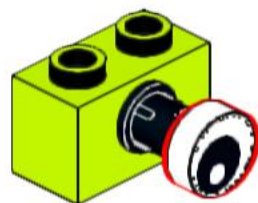
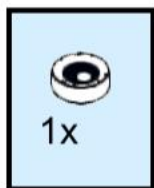



# 25

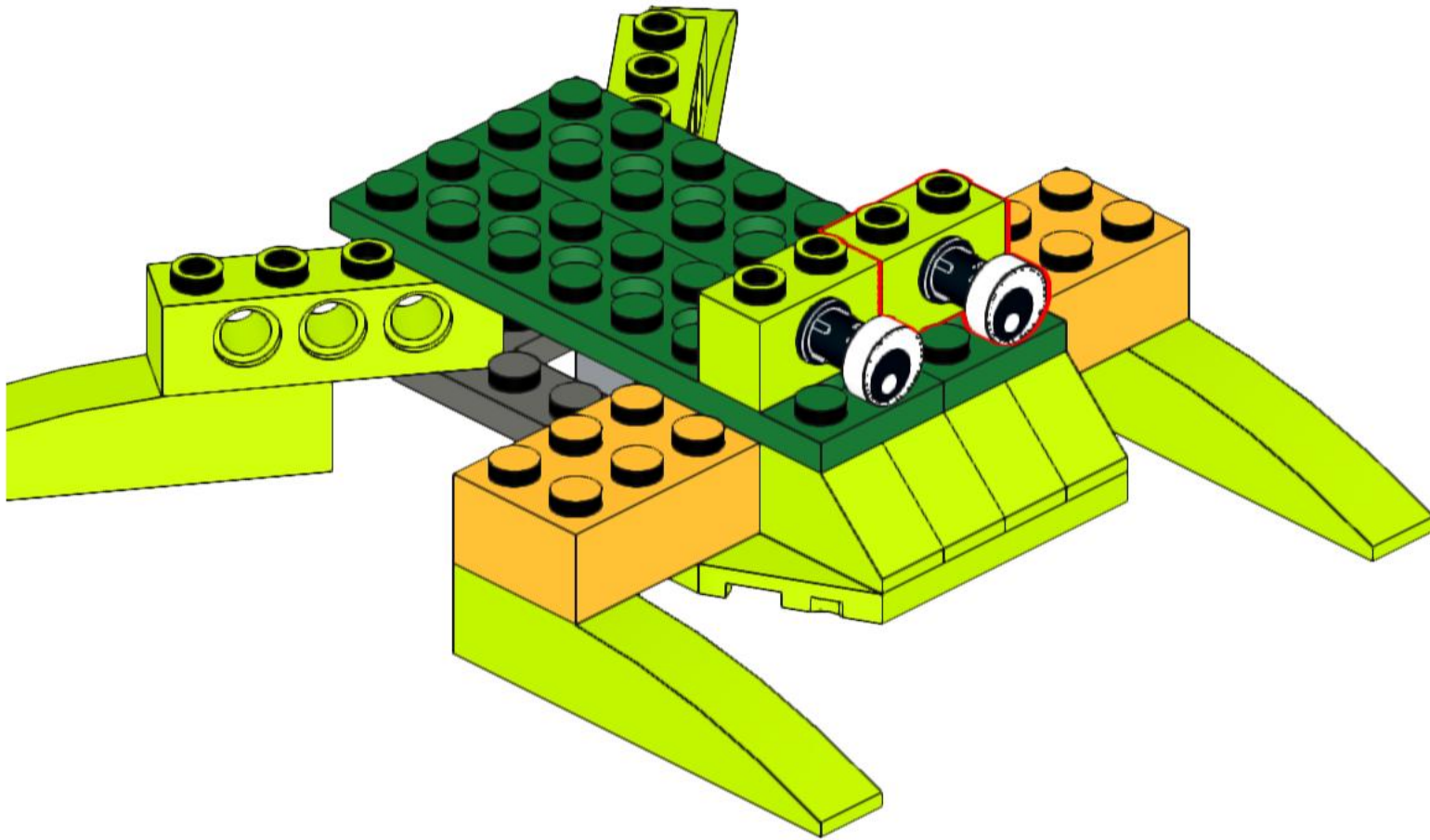
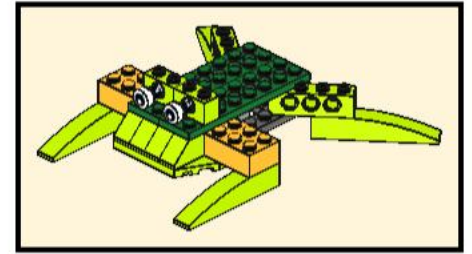

# 26

Connect both frogs to the Big Brick. It doesn't matter which plug they go into.

